

Electro-Magnetic Single Disc Clutches SFM and Brakes PBM

Service Manual

P-2086-WE
SM304-gb-08/04



 **Warner**[®]
Electric

An Altra Industrial Motion Company



We, **WARNER ELECTRIC EUROPE**, 7, rue Champfleury, B.P. 20095, F-49182 St Barthélemy d'Anjou Cedex declare that the clutches and brakes made in our factories from St Barthélemy d'Anjou, and hereafter designated : **SFM and PBM**

are exclusively designed for incorporation into a machine and to be assembled with other equipments to create a machine. The operation of the product is submitted to the conformity of the complete equipment, following the provisions of the machinery directive 89/392/EEC and if electric to the EMC directive 89/336 /EEC.

The conformity of the electric units to the Low Voltage directive 72/23 is supported by the full respect of the following standards : NFC 79300 and VDE 05808/8.65.

Drawn up in St Barthélemy d'Anjou, July 2002
E. PRAT, General Managing Director

CONTENTS

				
1	Technical specifications	2	3.3 Installation	3
2	Precautions and restrictions on use	2	3.3.1 SFM VAR00 and VAR01	3
2.1	Restrictions on use	2	3.3.2 SFM VAR10 and VAR11	3-4
2.2	Precautions and safety measures	2	3.3.3 PBM VAR00, VAR01 and VAR02	4
3	Installation	3	4 Electrical connection	5
3.1	Transport - storage	3	4.1 Important recommendations	5
3.2	Handling	3	4.2 Power supply	5
			5 Appendices	6-7

1 Technical specifications

SFM Sizes			10	20	40	70	150	250	500
Max. Speed		min ⁻¹	8000	6000	5000	4000	3000	2500	2000
Nominal airgap (0/+0,1)		mm	0,2	0,2	0,2	0,3	0,3	0,5	0,5
Dimension M	VAR00	mm	24	26,5	30	33,5	37,5	44	51
Weight	VAR00	kg	0,5	0,9	1,7	3	5,5	10	18,5
Weight	VAR01	kg	0,59	1,1	2,07	3,6	6,9	13,1	24,5
Weight	VAR10	kg	0,7	1,2	2,3	4	7,6	13	22,2
Weight	VAR11	kg	0,79	1,4	2,67	4,6	9	16,1	28,2

PBM Sizes			10	20	40	70	150	250	500
Max. Speed		min ⁻¹	8000	6000	5000	4000	3000	2500	2000
Nominal airgap (0/+0,1)		mm	0,2	0,2	0,2	0,3	0,3	0,5	0,5
Weight	VAR00	kg	0,3	0,5	0,95	1,7	3,3	5,9	11,5
Weight	VAR01/VAR02	kg	0,4	0,7	1,32	2,32	4,8	9	17,6

Table 1

2 Precautions and restrictions on use

2.1 Restrictions on use

 This equipment is designed for dry running. Any oily material alters performance.

 Exceeding the maximum rotation speed stated in the catalogue invalidates the warranty.

 This equipment is designed for a maximum ambient temperature of 40°C (155°C casing class).

2.2 Precautions and safety measures

 During the maintenance period make sure that the moving parts of the machine are stationary and that there is no risk of start-up.

 Any modification made to the unit without any express approval of a Warner Electric representative will invalidate the guarantee and release Warner Electric from any liability regarding conformity.



Symbol designating an action that might damage the apparatus



Symbol designating an action that might be dangerous to human safety

3 Installation

3.1 Transport / storage

These units are delivered in packaging that guarantees a 6 months storage period whether transported by land, by air, or by sea to any destination excepting tropical countries.

3.2 Handling



Avoid any impacts on the equipment so as not to alter their performance.



Never carry the equipment by the electrical supply cable.

3.3 Installation 3.3.1 SFM (VAR00 and VAR01)

Inductor (104) should be fixed to the frame of the machine, centred by the collar (see figure 1) or directly centred on a bearing forming a support (see figure 2). In this case, a circlip fitted in the groove provided for the purpose holds it central to the bearing.



In the case of collar centring, we specify an H9 tolerance.

The setover between the housing and shaft should not exceed 0.05 mm.

On VAR00, the armature (331) is fixed by means of CHC "profile head" screws (DIN 7984) locked by means of a LOCTITE 270 type thermoplastic liquid.

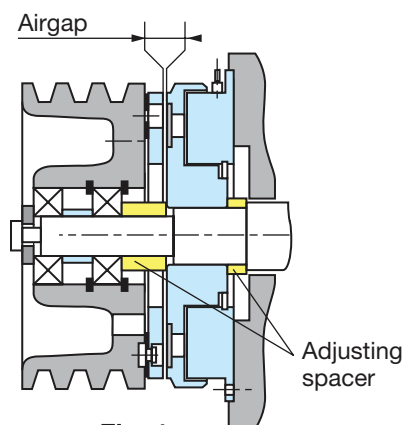

Fig. 1



In the case where two co-axial shafts are fitted, the recommended setover is 0.05 mm maximum. The angular misalignment should not be greater than 0,1 mm over a length of 100 mm.

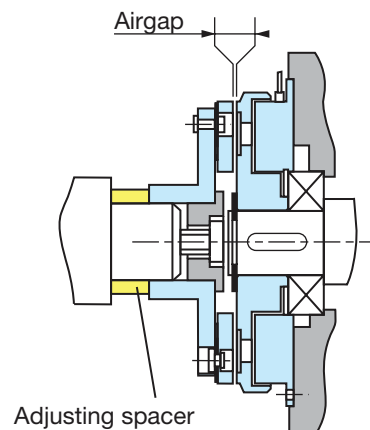

Fig. 2

On VAR01 the armature is mounted on a hub (332), supplied reamed to tolerance H7 and splined to tolerance P9.

The assembled hub / armature assembly should be secured centrally so as to respect the nominal airgap.

It is essential when assembling to respect the nominal airgap (see chapter 1) and dimension M (See table 1).



When assembling or dismantling the moving armature, **never hit or pull it**, this action could generate permanent distortion of the membrane-spring and malfunction.

3.3.2 SFM (VAR10 and VAR11)

The inductor (109) is stopped from rotating by means of a stop foot. This should be fitted so as to get a minimum play of 0,25 mm between the sides of the notch to avoid any strain on the inductor and internal bearing.

In case of vibrations, it is strongly recommended to insert a damping elastic slot between the anti-rotation device and the anti-rotation slot and to fix the coil's cable the nearest of it to avoid whipping.

On VAR10, the armature is fixed (331) by means of CHC "profile head" screws (DIN 7984) locked by means of a LOCTITE 270 type thermoplastic liquid.

The device supporting the moving armature should be secured centrally so as to respect the nominal airgap.

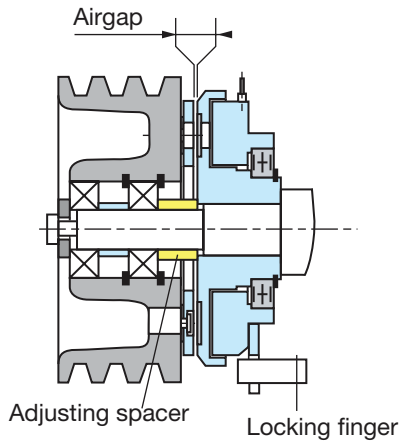

Fig. 3

On VAR11, the hub / moving armature assembly (332) is supplied reamed to tolerance H7 or H8 and splined to tolerance P9.

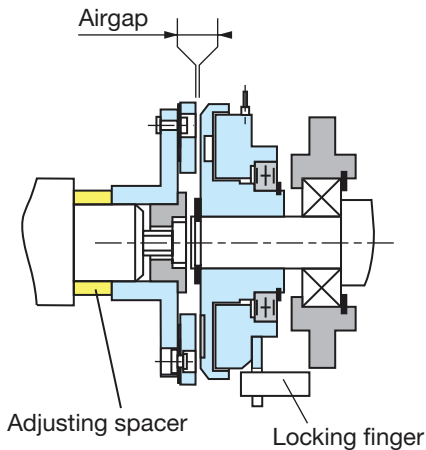

Fig. 4

When assembling or dismantling the moving armature, **never hit or pull it**, this action could generate permanent distortion of the membrane-spring and malfunction.

In the case where two co-axial shafts are fitted, the recommended setover is 0,05 mm maximum. The angular misalignment should not be greater than 0,1 mm over a length of 100 mm.

It is essential when assembling to respect the nominal airgap (see chapter 1).

3.3.3 PBM VAR00, VAR01 and VAR02

The inductor (104) should be rigidly fixed to the frame of the machine, centred by the collar (see figure 5) or directly centred on a bearing forming a support (see figure 6). In this case, a circlip fitted in the groove provided for the purpose holds it central to the bearing.

In the case of collar centring, we specify an H9 tolerance.

The setover between the housing and shaft should not exceed 0,2 mm.

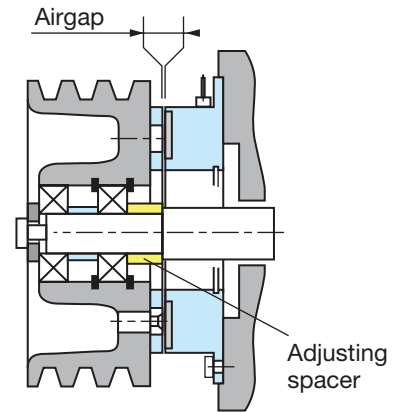

Fig. 5

On VAR00, the armature is fixed by means of CHC "profile head" screws (DIN 7984) locked by means of a LOCTITE 270 type thermoplastic liquid.

On VAR01 and VAR02 the armature is mounted on a hub (332) or (333), supplied reamed to tolerance H7 or H8 and splined to tolerance P9. The assembled hub / armature assembly should be secured centrally so as to respect the nominal airgap.

The angular misalignment of the shaft should not be greater than 0,1 mm over a length of 100 mm.

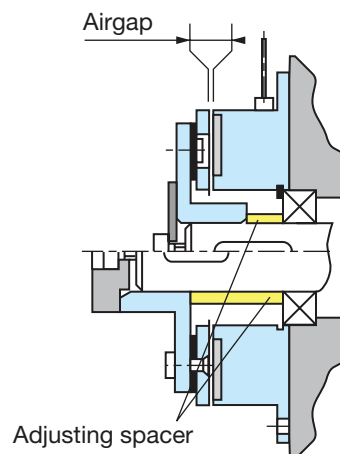

Fig. 6

When assembling or dismantling the moving armature, **never hit or pull it**, this action could generate permanent distortion of the membrane spring and malfunction.

It is essential when assembling to respect the nominal airgap (see chapter 1).

4 **Electrical connection**

SFM and PBM equipment should be supplied with Direct Current and has factory fitted wires of length 400 mm. Polarity has no effect on operation.

4.1 **Important recommendations**



Ensure that the nominal supply voltage is complied with (a lower voltage causes a reduction in the starting distance and transmissible torque).

The connecting wires should be of sufficient diameter to prevent power loss between source and the equipment to be supplied.

I (A) / L (m)	0 to 10 m	from 10 to 20 m
0 to 2 (A)	1,5 mm ²	1,5 mm ²
3 to 6 (A)	1,5 mm ²	2,5 mm ²

Tolerance for the supply to the clutch or brake terminals +5% / -10% (NF C 79-300)

4.2 **Power supply**

For the control of these clutches and brakes we advise the use of Warner Electric CBC 140-4, CBC 140-6, CBC 400, CBC 450, CBC 500, CBC 550, and CBC 700 supply units.

Warner Electric supply units provide protection for the coils and circuits. In the case where a brake or clutch is used without our supply units, with switch on the DC circuit, it is essential to protect the coil against power spikes by a varistor fitted in parallel.

5 **Appendices**

5.1 **Appendix 1**

SFM VAR00

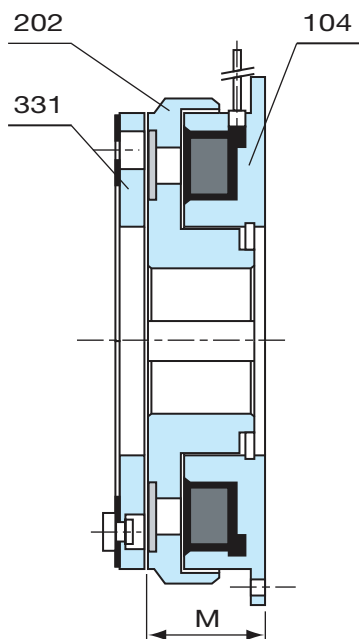

Rep	Designation
104	Magnet
202	Rotor + friction material
331	Assembled moving armature

SFM VAR01

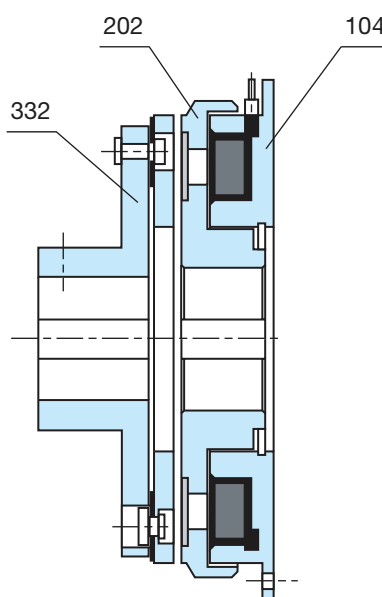

Rep	Designation
104	Magnet
202	Rotor + friction material
332	Moving armature ext. Hub

SFM VAR10

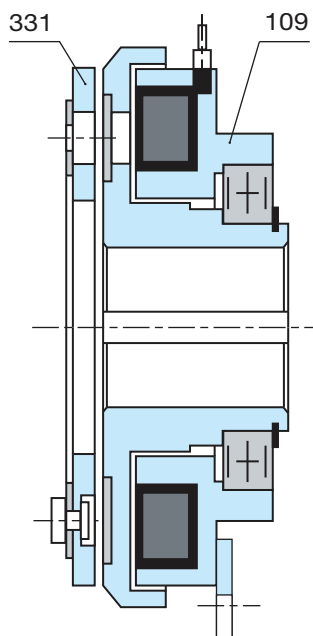

Rep	Designation
109	Magnet
331	Assembled moving armature

SFM VAR11

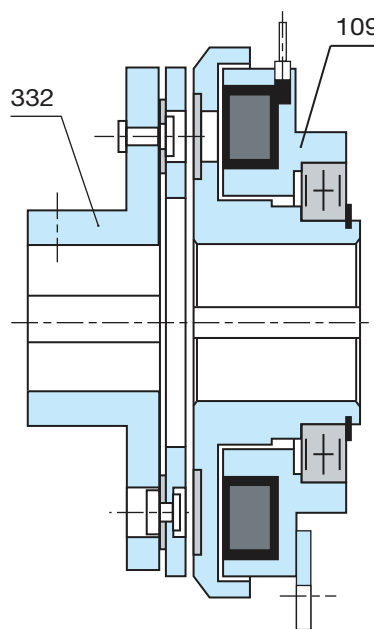

Rep	Designation
109	Magnet
332	Moving armature ext. Hub

5.2 Appendix 2

PBM VAR00

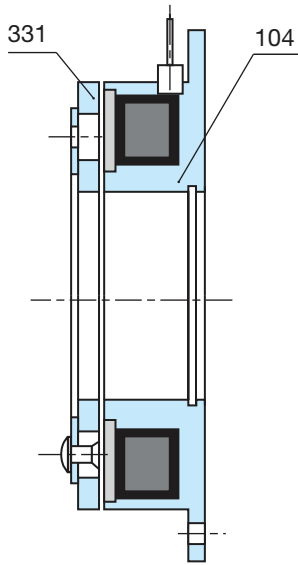

Rep	Designation
104	Magnet
331	Assembled moving armature

PBM VAR01

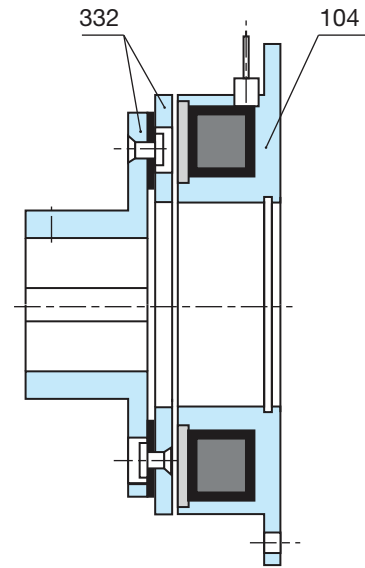

Rep	Designation
104	Magnet
332	Moving armature ext. Hub

PBM VAR02

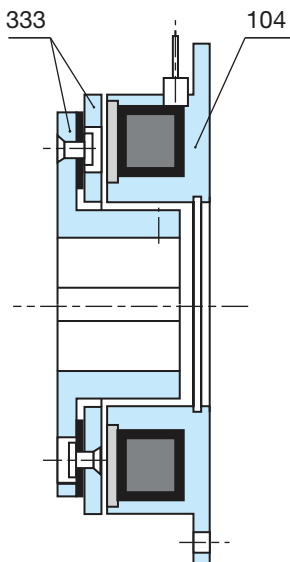

Rep	Designation
104	Magnet
333	Moving armature ext. Hub

Warranty

Warner Electric LLC warrants that it will repair or replace (whichever it deems advisable) any product manufactured and sold by it which proves to be defective in material or workmanship within a period of one (1) year from the date of original purchase for consumer, commercial or industrial use.

This warranty extends only to the original purchaser and is not transferable or assignable without Warner Electric LLC's prior consent.

Warranty service can be obtained in the U.S.A. by returning any defective product, transportation charges prepaid, to the appropriate Warner Electric LLC factory. Additional warranty information may be obtained by writing the Customer Satisfaction Department, Warner Electric LLC, 449 Gardner Street, South Beloit, Illinois 61080, or by calling 815-389-3771.

A purchase receipt or other proof of original purchase will be required before warranty service is rendered. If found defective under the terms of this warranty, repair or replacement will be made, without charge, together with a refund for transportation costs. If found not to be defective, you will be notified and, with your consent, the item will be repaired or replaced and returned to you at your expense.

This warranty covers normal use and does not cover damage or defect which results from alteration, accident, neglect, or improper installation, operation, or maintenance.

Some states do not allow limitation on how long an implied warranty lasts, so the above limitation may not apply to you.

Warner Electric LLC's obligation under this warranty is limited to the repair or replacement of the defective product and in no event shall Warner Electric LLC be liable for consequential, indirect, or incidental damages of any kind incurred by reason of the manufacture, sale or use of any defective product. Warner Electric LLC neither assumes nor authorizes any other person to give any other warranty or to assume any other obligation or liability on its behalf.

WITH RESPECT TO CONSUMER USE OF THE PRODUCT, ANY IMPLIED WARRANTIES WHICH THE CONSUMER MAY HAVE ARE LIMITED IN DURATION TO ONE YEAR FROM THE DATE OF ORIGINAL CONSUMER PURCHASE. WITH RESPECT TO COMMERCIAL AND INDUSTRIAL USES OF THE PRODUCT, THE FOREGOING WARRANTY IS IN LIEU OF AND EXCLUDES ALL OTHER WARRANTIES, WHETHER EXPRESSED OR IMPLIED BY OPERATION OF LAW OR OTHERWISE, INCLUDING, BUT NOT LIMITED TO, ANY IMPLIED WARRANTIES OF MERCHANTABILITY OR FITNESS.

Some states do not allow the exclusion or limitation of incidental or consequential damages, so the above limitation or exclusion may not apply to you. This warranty gives you specific legal rights and you may also have other rights which vary from state to state.

Changes in Dimensions and Specifications

All dimensions and specifications shown in Warner Electric catalogs are subject to change without notice. Weights do not include weight of boxing for shipment. Certified prints will be furnished without charge on request to Warner Electric.



Warner Electric Europe
7 rue Champfleu, B.P. 20095, St Barthelemy d'Anjou - France
+33 (0)2 41 21 24 24 • Fax: +33 (0)2 41 21 24 70
www.warnerelectric.com